

DH-IPC-HFW2200R-Z/VF

2Megapixel Full HD Network Water-proof IR-Bullet Camera



Features

- 1/2.8" 2Megapixel progressive Exmor CMOS
- H.264 & MJPEG dual-stream encoding
- 25/30fps@1080P(1920x1080) & 25/30fps@720P(1280x720)
- DWDR, Day/Night(ICR), 3DNR, AWB, AGC, BLC
- Multiple network monitoring: Web viewer, CMS(DSS/PSS) & DMSS
- 2.7~12mm varifocal lens
- Max IR LEDs Length 30m
- IP66, PoE

DH-IPC-HFW2200R-Z/VF

Technical Specifications

Model	DH-IPC-HFW2200R-VF	DH-IPC-HFW2200R-Z
Camera		
Image Sensor	1/2.8" 2Megapixel progressive scan Sony Exmor CMOS	
Effective Pixels	1920(H)x1080(V)	
Scanning System	Progressive	
Electronic Shutter Speed	Auto/Manual, 1/3(4)~1/10000s	
Min. Illumination	0.01Lux/F1.4 (Color), 0Lux/F1.4(IR on)	
S/N Ratio	More than 50dB	
Video Output	N/A	
Camera Features		
Max. IR LEDs Length	30m	
Day/Night	Auto(ICR)/Color/B/W	
Backlight Compensation	BLC / HLC / DWDR	
White Balance	Auto/Manual	
Gain Control	Auto/Manual	
Noise Reduction	3D	
Privacy Masking	Up to 4 areas	
Lens		
Focal Length	2.7mm~12mm	2.7mm~12mm
Max Aperture	F1.4	F1.4
Focus Control	Manual	Auto
Angle of View	H: 98.1° ~ 29.9°	H: 98.1° ~ 29.9°
Lens Type	Manual/ Fixed Iris	Motorized/ Fixed Iris
Mount Type	Board-in Type	Board-in Type
Video		
Compression	H.264/ H.264H/ MJPEG	
Resolution	1080P(1920x1080)/1.3M(1280x960)/720P(1280x720)/D1(704x576 /704x480)/CIF(352x288/352x240)	
Frame Rate	Main Stream	1080P/960P/720P(1 ~ 25/30fps)
	Sub Stream	D1/CIF(1 ~ 25/30fps)
Bit Rate	H.264H: 40 ~ 8192Kbps	
Audio		
Compression	N/A	
Interface	N/A	
Network		
Ethernet	RJ-45 (10/100Base-T)	
Wi-Fi	N/A	
Protocol	IPv4/IPv6, HTTP, HTTPS, SSL, TCP/IP, UDP, UPnP, ICMP, IGMP, SNMP, RTSP, RTP, SMTP, NTP, DHCP, DNS, PPPOE, DDNS, FTP, IP Filter, QoS, Bonjour	
Compatibility	ONVIF, CGI, PSIA	
Max. User Access	20 users	

DH-IPC-HFW2200R-Z/VF

Smart Phone	iPhone, iPad, Android, Windows Phone	
Auxiliary Interface		
Memory Slot	N/A	
RS485	N/A	
Alarm	N/A	
PIR Sensor Range	N/A	
General		
Power Supply	DC12V/PoE (802.3af)	
Power Consumption	Max 4.5W	Max 8.5W
Working Environment	-30°C~+60°C, Less than 95% RH	
Ingress Protection	IP66	
Vandal Resistance	N/A	
Dimensions	72mm×80mm×212.8mm	
Weight	0.65kg	

DH-IPC-HFW2200R-Z/VF

Dimensions (mm)

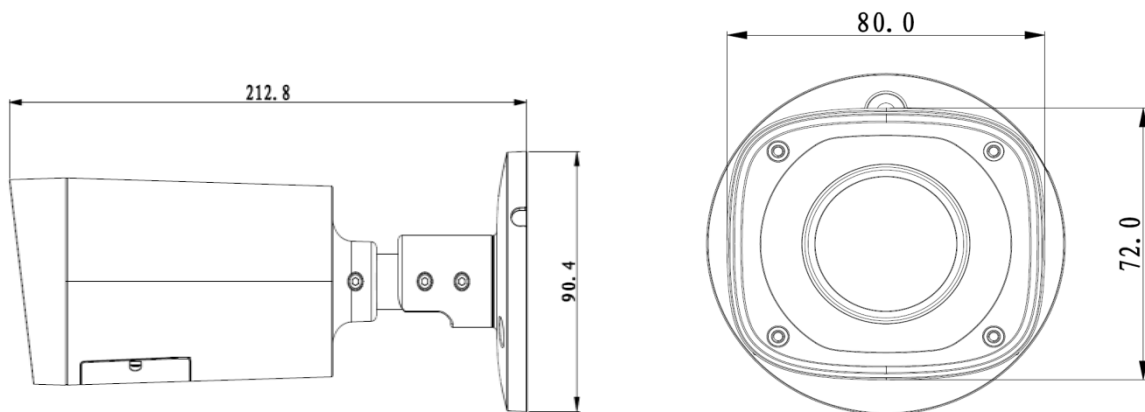

Accessory (optional)



Dahua Technology Co., Ltd.

1199 BinAn Road, Binjiang District, Hangzhou, China

Tel: +86-571-87688883

Fax: +86-571-87688815

Email: overseas@dahuatech.com

www.dahuasecurity.com

*Design and specifications are subject to change without notice.

© 2014 Dahua Technology Co., Ltd.